

# CABINET DOOR HINGE "BONSAI" FOR 12MM PANELS

Application:  
For inset doors  
For wood/glass or wood/wood (HPL) cabinets  
Drilling/cutting required  
92 or 182 degrees opening

Material: Brass  
Size: 42 x 20 x 31 mm  
Cabinet panel thickness: 12 mm

Door thickness: 4 - 6 mm  
Max door size: 600 x 2000 x 6 mm  
Max load capacity: 5 kg per hinge

Item No.:  
Chrome plated # 15.06.530  
Black matt # 15.06.531  
Brass polished # 15.06.532



**PATENTED**



Door processing.

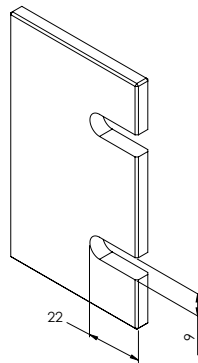

Cabinet processing.

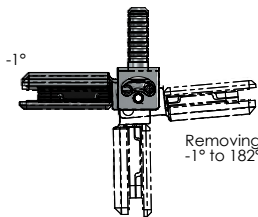
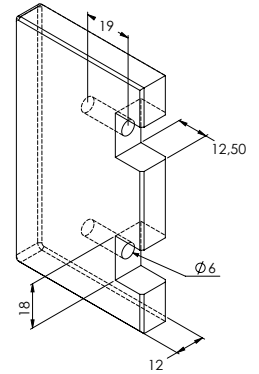

Removing the split enables a  
-1° to 182° opening

Standard opening angle: -1° to 92°

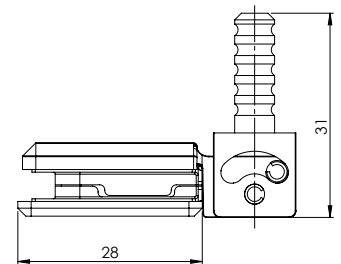
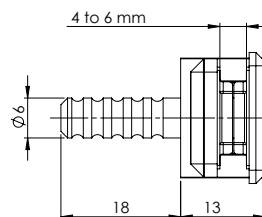
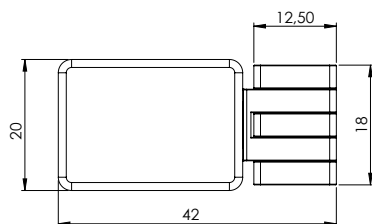
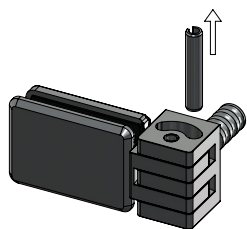
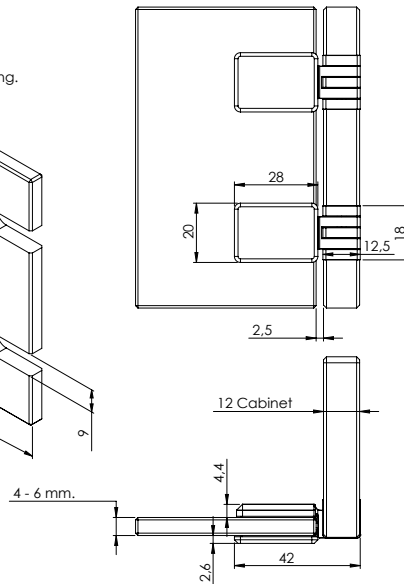

**SISO A/S**

Mileparken 11 Phone: (+45) 45 830 900  
DK - 2740 Skovlunde (Copenhagen) E-mail: siso@siso.dk  
Denmark Web: www.siso.dk